



Automation for swing gates



FLEX

1,60 m



Designed for small posts

The automation system for swing gates can be installed quickly on posts as small as 8 cm (3 1/4). Created solely for small residential swing gates (up to 1.6 m; 5 ft per leaf). Particularly indicated for pedestrian gates.



The advantages of the automatic pedestrian gate:

- Low cost and fast installation.
- No need for modifications to the existing gate.
- The same radio transmitter can be used for garage or vehicular gates.
- It can accommodate inputs from any access control system: card reader, telephone entry or safety photocells.
- Low voltage operation 24V D.C.
- The obstacle detection feature stops the gate upon sensing an obstruction in any direction.

It is a versatile automation:

- It can be installed quickly on any post, even if small. It adapts to different requirements.
- The electric lock maintains the gate securely closed and can be released with a key.
- An optional straight arm can be used for reduced column-wall spaces.
- Continuous duty due to its low voltage operation.
- Smooth operation over time. As with the rest of CAME products no periodic maintenance of the operator is required because of its permanent fluid grease lubrication system.



It is also easy for garage doors

With the same simplicity of installation and use, FLEX is also ideal for opening small swing garage doors. The electric lock assures the extra security for your property.



Technical characteristics

Technical information

Protection level	IP54 (NEMA 3)
Power supply	230V (110V) A.C.
Motor power supply	24V D.C.
Capacity	48 W
Duty cycle	intensive operation
Max torque	100 N•m
Opening time	13S complete 90° (with articulated arm)
Opening time	9S complete 90° (with straight arm)
Operating temperature	-20°C min. +70°C max.

Use limits (1 Kg = 2,2 LBS - 1 m = 3,2 ft)

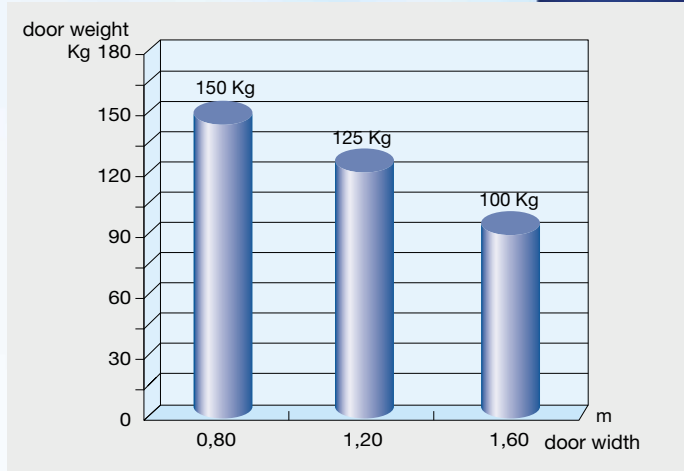

Overall dimensions

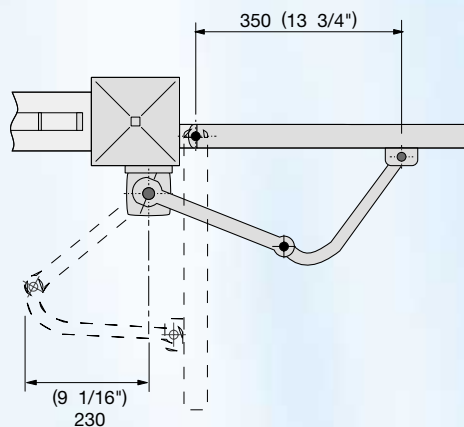
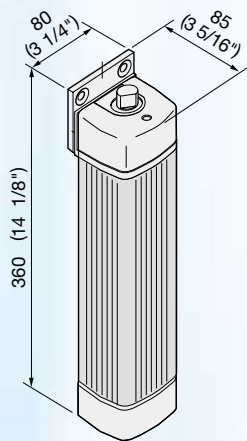

Swing gate system for industrial passage

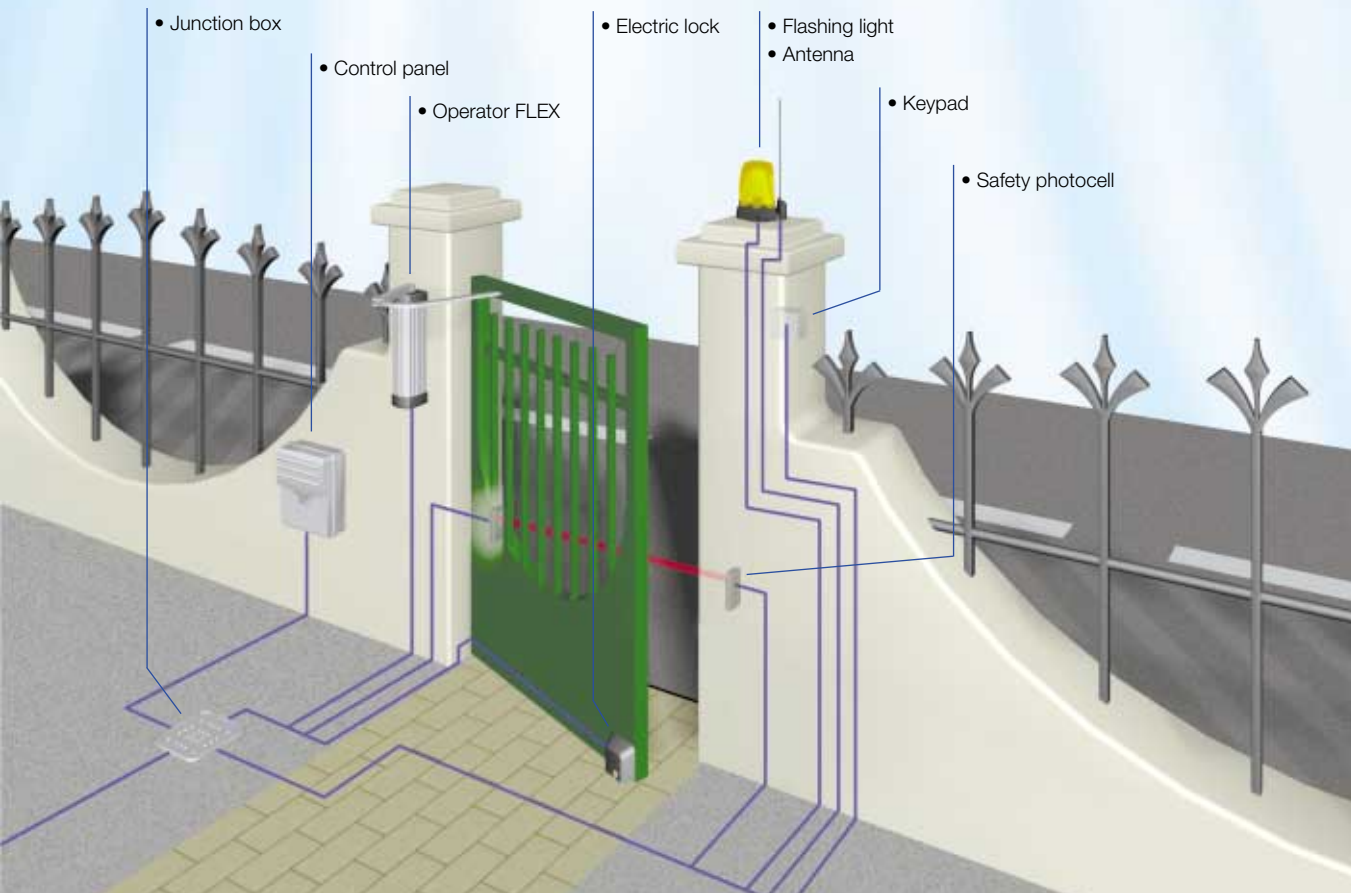

Applications

ATI

3/5 m



Sturdy, powerful and electromechanical:

these are the qualities that allow this automation system to be reliable over time, even with large gates.

CAME offers a complete selection of linear electromechanical gate operators that do not require periodic maintenance or internal adjustments.



An automation solution for every need

The possibility to choose from 11 different operators to meet various applications and requirements such as:

- **Gate dimensions:** from 1.8 mt (5 ft); 3 mt (9 ft) or 5 mt (15 ft).
- **Type of operation:** residential or commercial.
- **Gate structure and design:** ATI, KRONO models vary in design and external finish to blend with the design of the gate.
- **Large single leaf gates:** with the ATI 5000 / KRONO5 series, gates of up to 5 mt (15 ft) can be operated even in continuous cycle applications.
- **Simplified manual release:** all models either reversible or self-locking provide a manual release mechanism in case of power failure. An optional cord release mechanism for the ATI and KRONO series (H 3000) is available.

Sturdy, powerful and electromechanical

The ATI and KRONO models are built in aluminum to guarantee their sturdiness, compactness and resistance to adverse atmospheric conditions.



Also for condominiums and intensive traffic applications

The 24 V D.C. models are designed for continuous duty operation. Slow down at opening and closing. It can accommodate inputs from any access control system: radio transmitter, card reader, telephone entry or safety device loops or photocells.

They incorporate an optional battery backup system in case of power failure. The safety features of the 24V system include the possibility to adjust the travel speed as well as the slowdown speed in opening and closing.

The obstacle detection feature reverses the movement of the gate, in either direction, upon sensing an obstacle.



KRONO

3/5 m



Technical characteristics

Overall dimensions

KRONO

3/5 m
(9/15 ft)

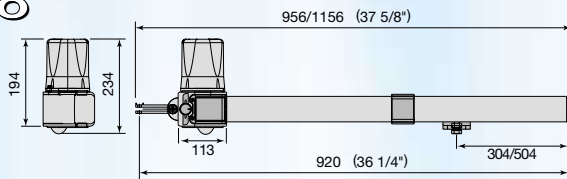

ATI

3/5 m
(9/15 ft)

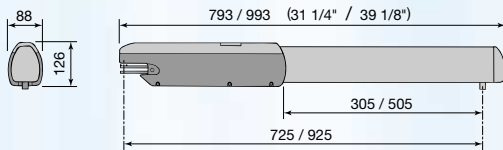

Use limits (1 Kg = 2,2 LBS - 1 m = 3,2 ft)

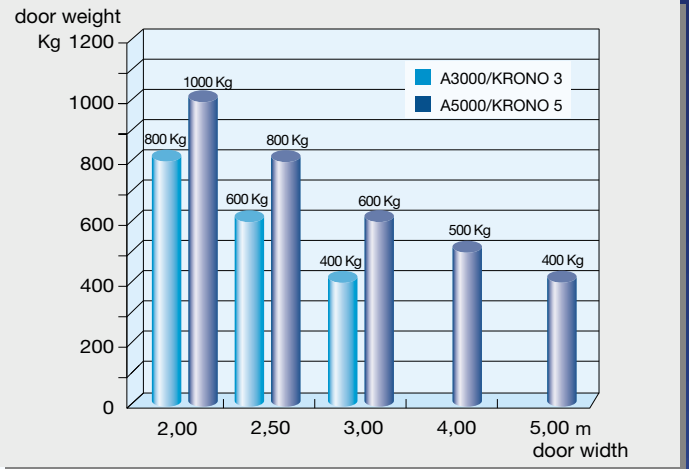

Technical information

Serie	KRONO			ATI		
	KRONO 3/5	A3000/3100	A 3006/3106	A 5000/5100	A 5006/5106	A 3024/5024
Types						
Protection level	IP54 (NEMA 3)			IP54 (NEMA 3)		
Power supply	230V (110V)	230V (110V)	230V (110V)	230V (110V)	230V (110V)	230V (110V) / 24V
Motor power supply	230V (110V)	230V (110V)	230V (110V)	230V (110V)	230V (110V)	24V
Capacity	130 W	150 W	150 W	150 W	150 W	120 W
Duty cycle	30%	50%	50%	50%	50%	intensive oper.
Thrust	400 ÷ 3000 N			400 ÷ 3000 N		
Motor thermal protection	150°C	150°C	150°C	150°C	150°C	
Opening time (90°)	22S/26S	19S	28S	32S	45S	adjustable
Operating temperature	-20°C min. +70°C max.					

Swing gate system for industrial passage

• Junction box

- Flashing light
- Antenna

- Control panel
- Radio receiver incorporated

- Radio transmitter

- Safety photocells
H = 0,5 m
H = 1 m

• ATI UNIT

• External release system

- Photocell column
H = 0,5 m
H = 1 m

Applications



FROG

3,5 m



Hidden Power

FROG is the most functional, desirable solution for any type of swing gate.

It is the best way to automate a gate without altering its shape and design.

In the CAME tradition the reduction gear is electromechanical, to ensure smooth precise and safe movement over time.



An automation solution that makes the difference

High efficiency operators

- **They are sturdy, quiet, but above all electromechanical:** care in the choice of materials used, its construction with a permanent fluid grease lubrication, but above all the fact that it is **electromechanical**, eliminates the need for periodic maintenance of the operators.
- **Watertight (IP67; NEMA 6)** for uninterrupted operation even under severe rain.

The setting and durability of the foundation case

- **Set during the gate installation**, the operator is mounted at a later time, thus, assuring a correct installation and cost efficiency.
- **Anti-corrosive** and resistant to the elements, made of stainless steel and protected with a special galvanized treatment. For extreme applications in the presence of corrosive elements, the STAINLESS STEEL (FROG BI) version is also available.

It safely locks, opens and relocks

During a power outage, everything is simpler even for the versions powered with 230V (110V).

CAME offers the possibility of choosing among three new door release solutions, both ORIGINAL and PATENTED, for the perfect solution to individual requirements:

- **a basic solution** with a release lever, simple and practical. It is the fastest and most convenient solution;
- **there are two more sophisticated versions**, whose doors unlock only via a special three-sided key or with a personalised DIN cylinder key.

The key versions also offer an additional feature: the gate manually locks in the closed position. During long power outages, the FROG release system allows you to open and securely close the gate.



Also for condominiums and intensive traffic applications

The 24V D.C. model is designed for continuous duty operation. Slow down at opening and closing. It can accommodate inputs from any access control system: radio transmitter, card reader, telephone entry or safety device loops or photocells. It can incorporate a battery backup system in case of power failure.



Technical characteristics

Technical information

Type	FROG-A	FROG-AV	FROG-A24
Protection level		IP67 (NEMA 6)	
Power supply		230V (110V) A.C.	
Motor power supply	230V (110V) A.C.	230V (110V) A.C.	24V D.C.
Capacity	200 W	300 W	180 W
Duty cycle	30%	30%	intensive oper.
Max torque	320 N•m	240 N•m	320 N•m
Motor thermal protection	150°C	150°C	
Opening time (90°)	18S	9S	from 16 to 45S
Operating temperature	-20°C min. +70°C max.		

Use limits (1 Kg = 2,2 LBS - 1 m = 3,2 ft)

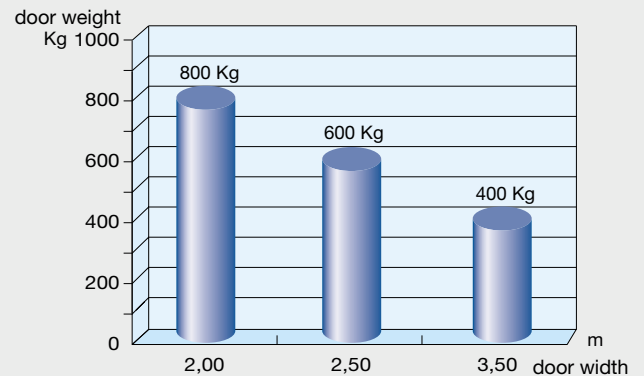

The standard opening is 110°; with the A 4370 and FL 180 accessories, the opening increases up to 140° and 180° respectively.

Overall dimensions

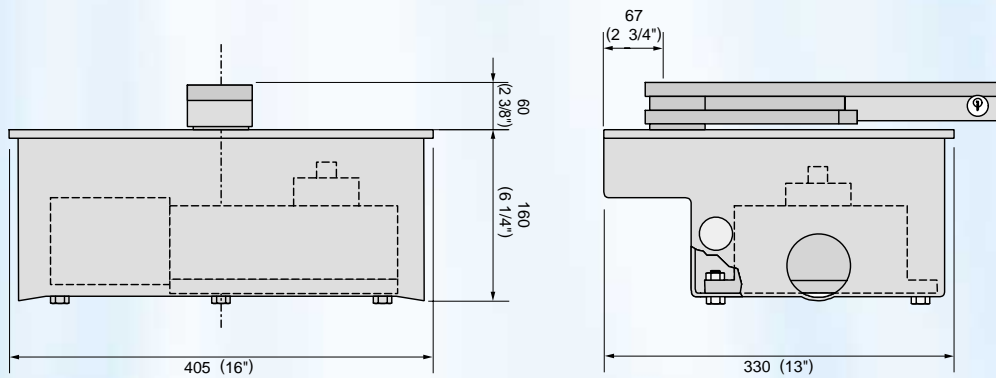

Swing gate system for industrial passage

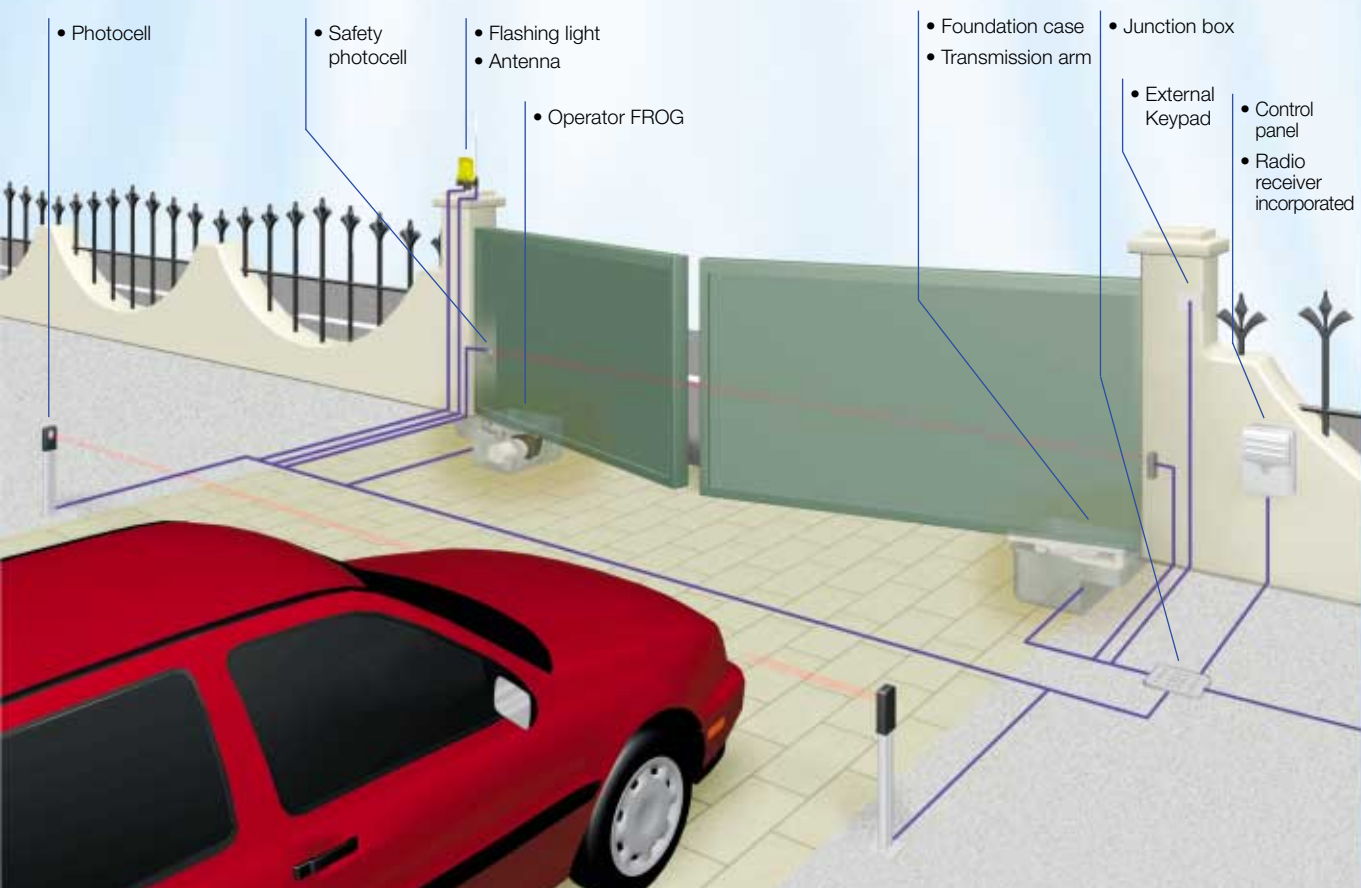

Applications

FAST

2,3 m



Quick to install automation

FAST is the new articulated transmission arm automation for gates with wings up to 2,3 m for each wing. A new product, which measures up to precise application demands: it can be installed on to relatively small posts and columns (from 20 cm (8")), and is particularly recommended for gates with distances of up to 20 cm (8") between the gate hinge and the edge of the column.



Total functionality in a compact form

- **Practical and safe** manual mechanism to release the gate in the absence of electricity; the device is also protected by a door locked with a personalised key.
- To further simplify the release operation, the device may also be integrated with a wire release system and accompanying safety box.
- All versions are also equipped with an electromechanical gearbox with **permanent, fluid grease lubrication** and a **weatherproof**, articulated transmission arm.
- **For special space needs**, FAST may be installed with an upright transmission arm, thereby nullifying any lateral impediment caused by lifting of the transmission during movement.

FAST is available in the convenient SET COMPLETE confection, for the automation of gates with 2 wings.

Electronics to size and simplification of the connections

Choosing an automation from the FAST series, with incorporated control panel, means assurance that the product is easy to install, where all of the installation operations and electrical connections have been simplified (F7000). Alternately, choosing an application outside of the control panel, you can select from among numerous electronic solutions according to the demands of the user.



Simplicity and safety in continual circuitry

In the 24V version, thanks to the ZL170 control panel, for single wing gates, a **tri-polar cable** connection is sufficient for motor power and for directing the deceleration and stopping.

Available Models

- F 7000** 230V operator complete with articulated arm and incorporated control panel
- F 7001** 230V operator complete with articulated arm.
- F 7024** 24V operator complete with articulated arm



Technical characteristics

Technical information

Type	F7000	F7001	F7024
Protection level	IP54 (NEMA3)		
Power supply	230V (110V) A.C.		
Motor power supply	230V (110V) A.C.	230V (110V) A.C.	24V D.C.
Capacity	160 W	160 W	140 W
Duty cycle	30%	30%	intensive oper.
Max torque	180 N•m	180 N•m	180 N•m
Motor thermal protection	150 °C	150 °C	
Opening time (90°)	18S	18S	from 16 to 45S
Operating temperature	-20°C min. +70°C max.		

Use limits (1 Kg = 2,2 LBS - 1 m = 3,2 ft)

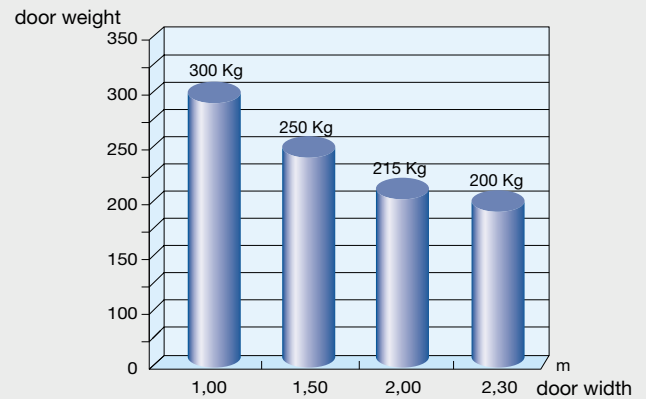

FAST can be applied to single doors up to 2,3 mt (7,5 ft) wide, with distances of up to 200 mm (8") between the hinge of the gate and the edge of the column.

Overall dimensions

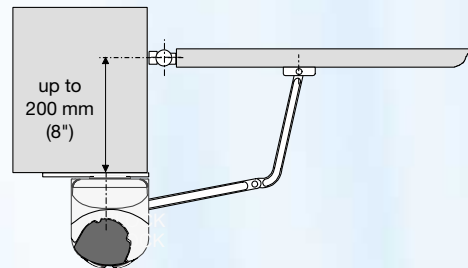
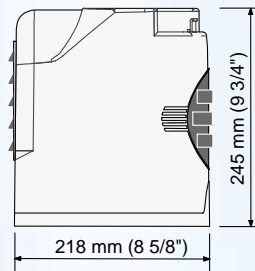
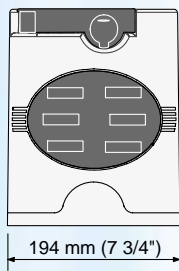

Swing gate system for industrial passage

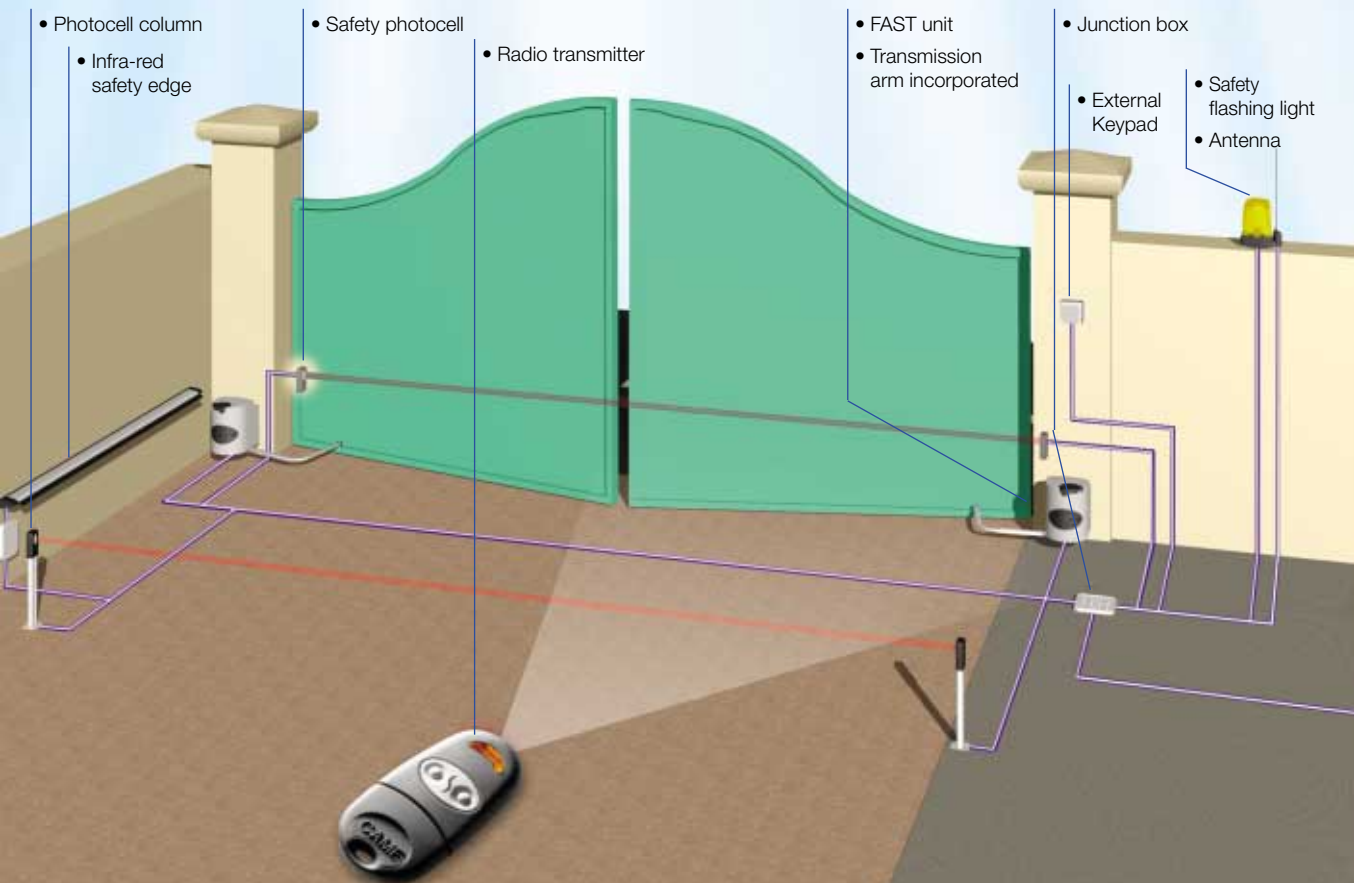

Applications



FERNI

4 m



The universal solution

A universal solution for gates installed on large posts where the installation of a linear operator is impractical or impossible.



A solution that is EASY and SAFE to install

- **No welding is necessary:** the operator can be mounted on any structure thanks to its mounting bracket.
- **No pinch point or scissor movement of the arms.**
- **Single model** for left or right side mounting.
- **Special space requirements** can use the straight telescopic arm instead of the articulated arm.
- The galvanized transmission arm **is highly resistant to extreme weather conditions.**

Three versions for a universal solution

Residential use

The F1000 230V (110V) model with self-locking gears: it is the automation system itself that guarantees the locking of the gates in the closed position. The manual release mechanism, protected by a door and key, easily unlocks the gears in case of power failure. An optional cord release mechanism model H 3000 is available.

The F1100 230V (110V) model without locking gears: recommended for gates over 2.50 mt (7 ft). The closure of the gate is guaranteed by means of an electric lock that allows for manual operation in case of power failure.

Commercial and condominium applications

The F1024 series commercial swing gate

operator is designed for continuous duty cycles along with safety features as in all CAME products. Slow down at opening and closing. It can accommodate inputs from any access control system: radio transmitter, card reader, telephone entry or safety device loops or photocells. It can incorporate an optional battery backup system in case of power failure. The safety features of the 24V system include the possibility to adjust the travel speed as well as the slowdown speed in opening and closing. The obstacle detection feature reverses the movement of the gate upon sensing an obstacle.



Sturdy, quiet and above all electromechanical

The careful choice of materials used, its construction with a permanent fluid grease lubrication, but above all the fact that it is **electromechanical**, eliminates the need for periodic maintenance of the operator.



Technical characteristics

Technical information

Type	F1000	F1100	F1024
Protection level	IP54 (NEMA 3)		
Power supply	230V (110V) A.C.		
Motor power supply	230V (110V) A.C.	230V (110V) A.C.	24V D.C.
Capacity	150 W	110 W	180 W
Duty cycle	50%	50%	intensive oper.
Max torque	320 N•m	380 N•m	470 N•m
Motor thermal protection	150°C	150 °C	
Opening time (90°)	18S	18S	from 16 to 45S
Operating temperature	-20°C min. +70°C max.		

Use limits (1 Kg = 2,2 LBS - 1 m = 3,2 ft)

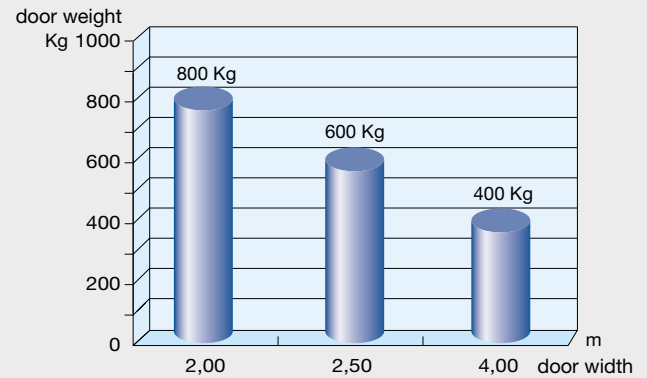

FERNI can be applied to single doors up to 4 mt (12 ft) wide, with distances of up to 380 mm (15") between the hinge of the gate and the edge of the column.

Overall dimensions

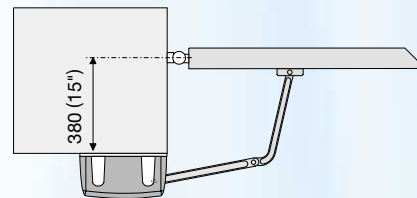
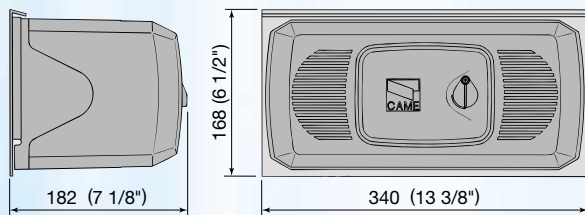

Swing gate system for industrial passage

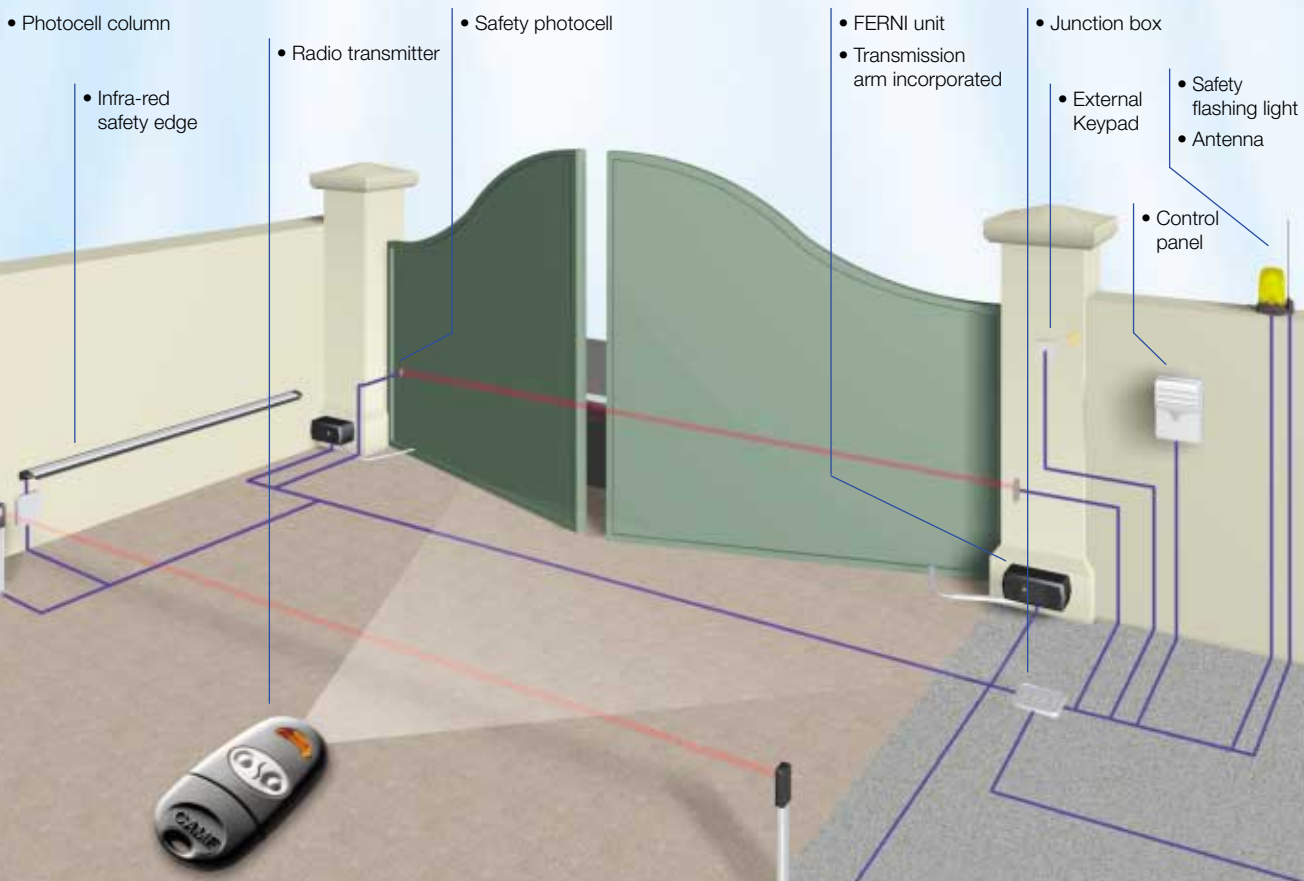

Applications





internet: www.came.it
e-mail: info@came.it



CAME CANCELLI AUTOMATICI S.P.A.
VIA MARTIRI DELLA LIBERTÀ, 15
31030 DOSSON DI CASIER
TREVISO - ITALY

CAME SUD S.R.L.
VIA FERRANTE IMPARATO, 198
CM2 LOTTO A/7
80146 NAPOLI - ITALY

CAME LOMBARDIA S.R.L.
PIAZZA CASTELLO, 16
20093 COLOGNO MONZESE
MILANO - ITALY

CAME FRANCE S.A.
7 RUE DES HARAS
92737 NANTERRE CEDEX
PARIS - FRANCE

CAME AUTATISMOS S.A.
C/JUAN DE MARIANA, 17
28045 MADRID
ESPAÑA

CAME AUTATISMOS CATALUNYA S.A.
POL. IND. MOLÍ DELS FRARES - CARRER A, 23
08620 SANT VICENÇ DELS HORTS
BARCELONA - ESPAÑA

CAME GmbH
BERGSTR., 17/1
70825 KORNTAL BEI STUTTGART
DEUTSCHLAND

CAME GmbH
AKAZIENSTR. 9
16356 SEEFELD BEI BERLIN
DEUTSCHLAND

CAME (AMERICA) L.L.C.
2293 NW 82 AVENUE
MIAMI (FL) 33122
U.S.A.

CAME UNITED KINGDOM LTD
UNIT 3, ORCHARD PARK IND. EST.
TOWN STREET, SANDIACRE
NOTTINGHAM - NG10 5BP - U.K.

CAME PL Sp. z.o.o.
UL. ORDONA, 1
01 - 237 WARSZAWA
POLAND

CAME BELGIUM
ZONING OUEST, 7
7860 LESSINES
BELGIE

CAME is Europe's leading manufacturer of a complete range of **electromechanical automatic** gate control systems. Top-quality control systems designed for external installation and with **no need of periodic maintenance** are the basis for the success of **CAME** products. **CAME** automatic systems can be fitted also on an existing gate: your local **CAME** dealer will be delighted to help you selecting the system which best suits your requirements.

The range of **CAME** automatic systems includes:

Automation for **sliding gates**

Automation for **swing gates**

Automation for **garage and sectional doors**

Automation for **shutters and industrial gates**

Automation for **car parks and street barriers**

Automatic Pedestrian doors

Systems for **access control**

Accessories for **control and safety**



PRODUCTS
CE